

Materials used:

Alloy EN-AW 6082 T6 (AlSi1MgMn)
 Main chords 50 x 2 mm
 Braces 16 x 2 mm
 Accessory/truss 4 x connecting cone, 8x pivot, 8x pin
 Item No. 60302895

Load table QUADLOCK 6082:				
Span (m)	Point load (kg)	Deflection (mm)	UDL (kg/m)	Deflection (mm)
2	1664	2,6	1655	3,2
4	832	10,3	416	12,9
6	555	23,3	185	29,1
8	416	41,4	104	51,7
10	332	64,6	66	80,8
12	277	93,0	46	116,3
14	238	126,6	34	158,3
16	208	165,4	27	206,8

Maximum system length: 16 meters

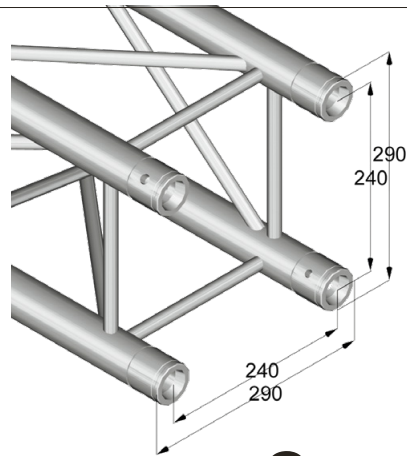

including connecting cone

Quadlock 6082



- No. 6030649A6082-210
- No. 6030649C6082-290
- No. 603065006082-500
- No. 603065016082-710
- No. 603065026082-750
- No. 603065036082-875
- No. 603065056082-1000
- No. 603065066082-1250
- No. 603065086082-1500
- No. 603065106082-2000
- No. 603065156082-2500
- No. 603065206082-3000
- No. 603065226082-3500
- No. 603065256082-4000
- No. 603065276082-4500
- No. 603065306082-5000

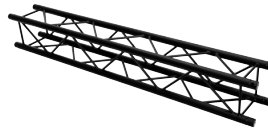

- No. 60306410S6082-210
- No. 60306412S6082-290
- No. 60306413S6082-500
- No. 60306416S6082-710
- No. 60306418S6082-750
- No. 60306421S6082-875
- No. 60306422S6082-1000
- No. 60306424S6082-1250
- No. 60306426S6082-1500
- No. 60306428S6082-2000
- No. 60306432S6082-2500
- No. 60306436S6082-3000
- No. 60306438S6082-3500
- No. 60306440S6082-4000
- No. 60306442S6082-4500
- No. 60306443S6082-5000

ALUTRUSS QUADLOCK 6082 4-Way Cross Beam

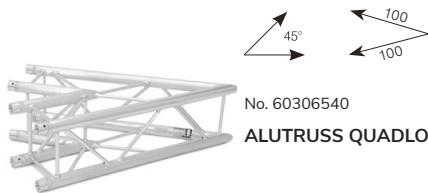

No. 60306540
ALUTRUSS QUADLOCK 6082C-19 2-Way Corner 45°

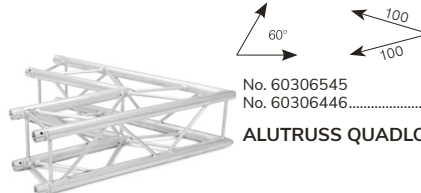

No. 60306545
No. 60306446black
ALUTRUSS QUADLOCK 6082C-20 2-Way Corner 60°

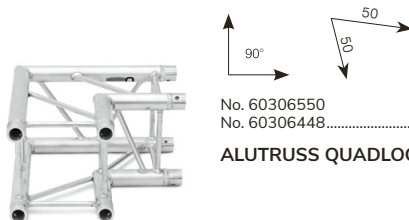

No. 60306550
No. 60306448black
ALUTRUSS QUADLOCK 6082C-21 2-Way Corner 90°

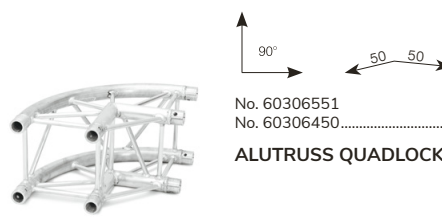

No. 60306551
No. 60306450black
ALUTRUSS QUADLOCK 6082C-21R 2-Way Corner 90°

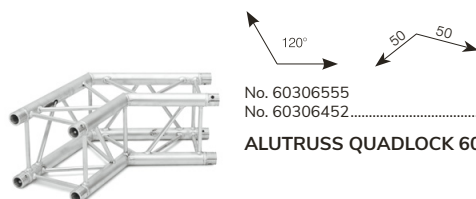

No. 60306555
No. 60306452black
ALUTRUSS QUADLOCK 6082C-22 2-Way Corner 120°

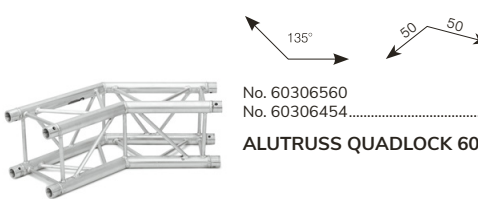

No. 60306560
No. 60306454black
ALUTRUSS QUADLOCK 6082C-23 2-Way Corner 135°